

Dimensional Diagram

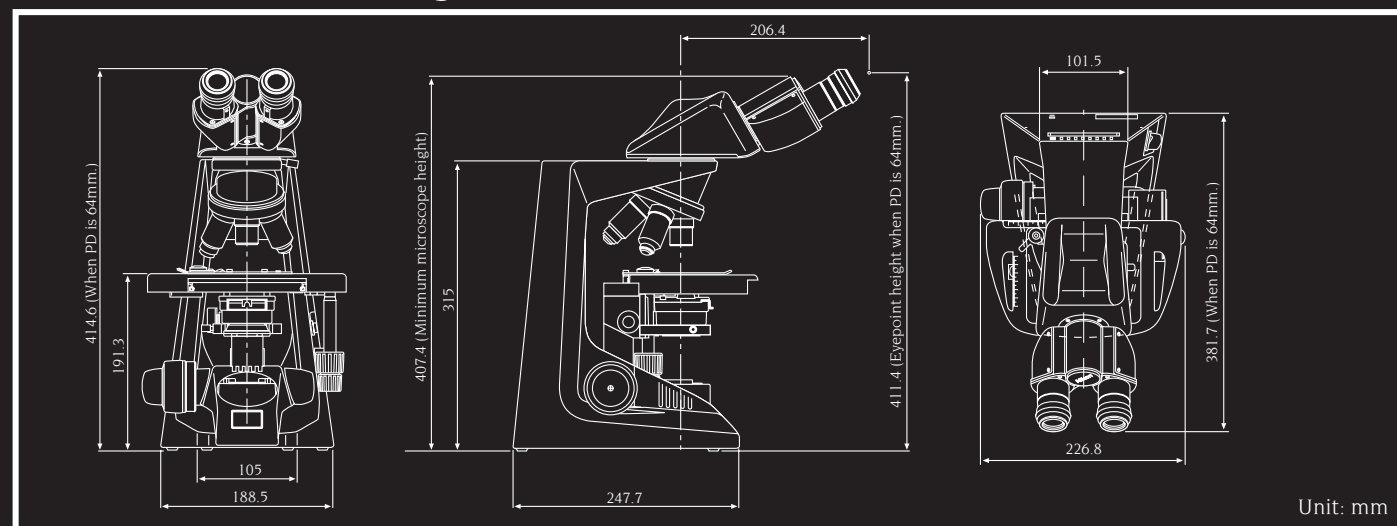

E200 Specifications

Optical system	CFI60 (infinity optical system) Parfocal distance: 60mm	CFI E Plan Achromat 40X N.A. 0.65 (W.D. 0.65mm) CFI E Plan Achromat 100X Oil N.A. 1.25 (W.D. 0.23mm) As an option, CFI Achromat DL and other higher-grade CFI60 objectives can be used
Magnification	40–1500X for observation 8–500X for 35mm photomicrography	
Eyepiece tube	E2-TB Binocular tube, E2-TF Trinocular tube Siedentopf type (Inclination: 30°, Interpupillary distance: 47-75 mm, 360° rotatable) C-TE Ergonomic Binocular Tube (inclination: 10-30°, extension: 40mm)	
Eyepiece	CFI E 10X (F.O.V.: 20mm), CFI E 15X (F.O.V.: 12mm)	
Photo lens	PLI projection lens: 2X, 2.5X, 4X, 5X	
Nosepiece	Quadruple nosepiece, reversed type	
Coarse/fine focusing	Fine: 0.2mm per rotation, Coarse: 37.7mm per rotation, Minimum reading: 2 microns on left-side fine control knob, Coarse motion torque adjustable, Refocusing system incorporated in stage, Stage handle and focusing knob are at equal distance from the operator	
Stage	Rectangular 216 x 150 mm surface stage mounted on the main body. Cross travel 78 x 54 mm using low-positioned X/Y coaxial control knob	
Objectives	CFI E Plan Achromat 4X N.A. 0.10 (W.D. 30mm) CFI E Plan Achromat 10X N.A. 0.25 (W.D. 0.7mm)	
Condenser	E2 Abbe condenser N.A. 1.25; leaf-type aperture diaphragm with position guide markings for respective CFI E Plan objectives Optional condensers: E2 Phase condenser N.A. 1.25; leaf-type aperture diaphragm with position guide markings for respective CFI Achromat DL objectives For microscope without field diaphragm: C-C Achromat Condenser Achromat Swing-out Condenser Darkfield Condenser, dry type C-C Phase Contrast Condenser	
Illumination system	6V-20W halogen bulb, 6V-30W halogen bulb	
Intermediate attachment*	E200 epi-fluorescence attachment, Teaching head (face-to-face and side-by-side types), Drawing tube, Eye level riser *Maximum intermediate space 50mm	

WARNING TO ENSURE CORRECT USAGE, READ THE CORRESPONDING MANUALS CAREFULLY BEFORE USING YOUR EQUIPMENT.

Specifications and equipment are subject to change without any notice or obligation on the part of the manufacturer. October 2008 ©2000-08 NIKON CORPORATION



NIKON CORPORATION

6-3, Nishiohi 1-chome, Shinagawa-ku,
Tokyo 140-8601, Japan
phone: +81-3-3773-8973 fax: +81-3-3773-8986
<http://www.nikon.com/products/instruments/>

NIKON INSTRUMENTS INC.

1300 Walt Whitman Road, Melville, N.Y. 11747-3064, U.S.A.
phone: +1-631-547-8500; +1-800-52-NIKON (within the U.S.A. only)
fax: +1-631-547-0306
<http://www.nikoninstruments.com/>

NIKON INSTRUMENTS EUROPE B.V.

Laan van Kronenburg 2, 1183 AS Amstelveen, The Netherlands
phone: +31-20-44-96-222 fax: +31-20-44-96-298
<http://www.nikoninstruments.eu/>

NIKON INSTRUMENTS (SHANGHAI) CO., LTD.

CHINA phone: +86-21-5836-0050 fax: +86-21-5836-0030
(Beijing branch) phone: +86-10-5869-2255 fax: +86-10-5869-2277
(Guangzhou branch) phone: +86-20-3882-0552 fax: +86-20-3882-0580

NIKON SINGAPORE PTE LTD

SINGAPORE phone: +65-6559-3618 fax: +65-6559-3668

NIKON MALAYSIA SDN. BHD.

MALAYSIA phone: +60-3-7809-3688 fax: +60-3-7809-3633

NIKON INSTRUMENTS KOREA CO., LTD.

KOREA phone: +82-2-2186-8410 fax: +82-2-555-4415

NIKON CANADA INC.

CANADA phone: +1-905-602-9676 fax: +1-905-602-9953

NIKON FRANCE S.A.S.

FRANCE phone: +33-1-4516-45-16 fax: +33-1-4516-45-55

NIKON GMBH

GERMANY phone: +49-211-941-42-20 fax: +49-211-941-43-22

NIKON INSTRUMENTS S.p.A.

ITALY phone: +39-055-300-96-01 fax: +39-055-30-09-93

NIKON AG

SWITZERLAND phone: +41-43-277-28-67 fax: +41-43-277-28-61



ISO 9001 Certified
NIKON CORPORATION
Instruments Company



ISO 14001 Certified
NIKON CORPORATION
Yokohama Plant



ECLIPSE E200

CFI60

The first microscope in its class to feature CFI60 infinity optics, plus an anti-mold design to ensure years of high-quality use



For the first time, the CFI60 optical system— infinity optics of the world's highest level—has been incorporated into a microscope of this class. The result is stunningly sharp and clear images at any magnification. Of course, the Eclipse E200 maintains the same operational ease and rigidity common to all Nikon microscopes and is compatible with many accessories for higher-grade Eclipse series microscopes.

Is mold a problem? Not any more.

By using anti-mold paint and sealing anti-mold agent inside the microscope at critical places, the Eclipse E200 is designed for use even in hot and humid environments.

Moreover, this instrument packs all of these features into a contemporary design that blends in with the clean interiors of your hospital and examination rooms.

Best of all, the Eclipse E200 is affordable. Once you use it, you'll realize what an outstanding performer it is, despite its modest price.



Eclipse E200-F
(model with field diaphragm)

Eclipse E200

Superb infinity optics, plus ergonomic touches

CFI60 optical system

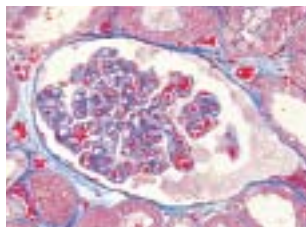

The CFI60 optical system combines Nikon's renowned CF optical design with infinity optics to overcome the limitations of the traditional infinity design. CFI60 optics

provide longer working distances and higher N.A.'s. These new optics deliver startlingly clear images at any magnification because chromatic aberrations and curvature of field are both corrected over the entire field of view when the field number is 20mm. Nikon developed new dedicated CFI E Plan Achromat objectives exclusively for the E200. Also, you can use other higher-grade objectives available for the Eclipse series whenever your laboratory situation calls for it.

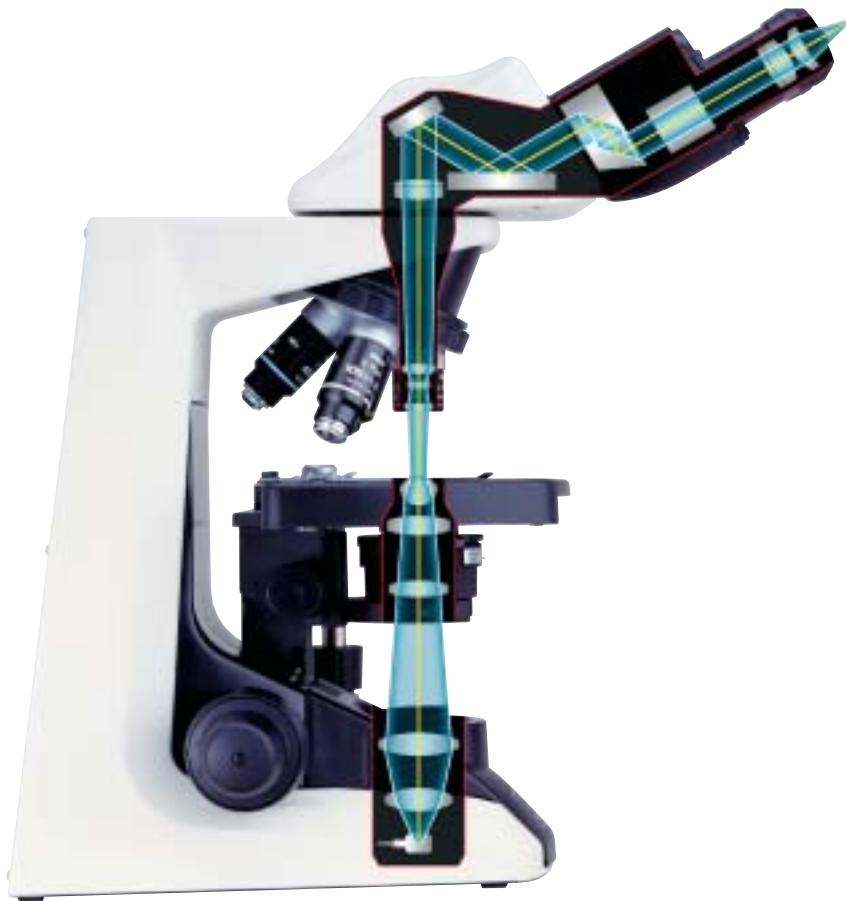

Anti-mold design

Mold is a formidable enemy of microscopes. Before you know it, it can begin growing on the interior optical surfaces of the microscope and ruin performance. Using anti-mold paint, plus anti-mold agent sealed at critical places inside the microscope, the Eclipse E200 is designed to resist mold growth. In tests, an anti-mold treated unit was able to resist the growth of mold for three consecutive years at an average temperature of 30° C (86° F) and 80% humidity.

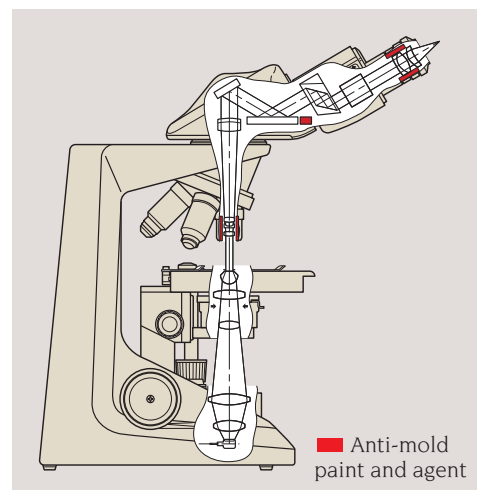

Anti-mold paint and agent

Improved

Ergonomic design equals comfortable operation

Comfort is ensured allowing long hours of use, thanks to Nikon's thoughtful ergonomic design. This is the same design incorporated into Nikon's other laboratory and research-grade Eclipse series microscopes.

For example, the focus knob and the stage handle are located equidistant from the operator, permitting one-handed operation in a natural posture without twisting the shoulders. Because these controls are low positioned, you can operate the microscope while resting your arms comfortably on the desk. Moreover, the low-profile stage makes exchange of specimen slides easy, while the low inclination angle eyepiece tube provides comfortable viewing.

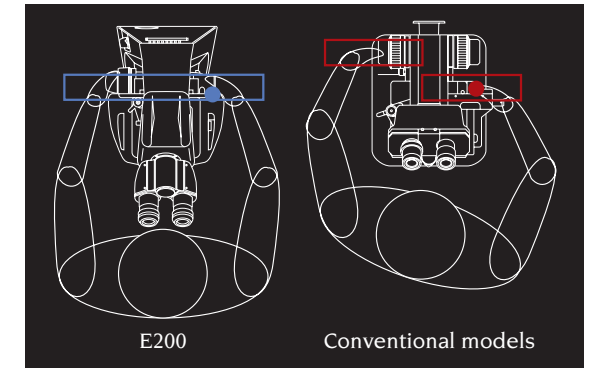

Comparison of the positions of the stage handle and focus control knob

Ergonomic binocular tube

With this option, users can adjust not only the eyepiece tube tilt angle, but the eyepiece length to suit their build, eliminating discomfort and strain during long hours of observation.

- * Use of this accessory in combination with other equipment may produce darker images around the periphery.
- * Must be attached directly to the main body.



View angle is adjustable by 10° to 30°.



Eyepiece length can be extended by up to 40mm.



E200 configured with an ergonomic binocular tube

Eye-level riser

Up to two eye-level risers can be mounted to raise the height of the eyepoint—25mm each for a total of 50mm.



Robust, vibration resistant construction

One-piece construction from arm to base, a stage design where its up/down mechanism is located in the base, plus a wide footprint of 188.5mm across the back all provide

greater rigidity and resistance to vibrations, contributing to superior images.

Design ideas that ensure superb optical quality and increased ease of use

CFI60 objectives

Nikon's exclusive CFI60 objectives provide numerous benefits: longer working distances, high numerical apertures, flat images over the entire field of view with virtually no curvature of field when the field number is 20mm. To match your laboratory requirements, the E200 provides a wide selection of objectives to choose from. These include the new CFI E Plan Achromat objectives developed for the E200 or other higher-grade Eclipse series objectives.



CFI E Plan Achromat objectives

Improved

Eyeiece tube

The Siedentopf-type eyepiece tube is inclined at 30 degrees to ensure comfortable viewing in a natural posture. Designed for use by operators with different builds, this eyepiece tube has a narrow minimum interpupillary distance of 47mm, while the eyepoint height can be raised 34mm when interpupillary distance is 64mm by simply swinging the front part of the eyepiece tube up 180°. For extremely tall users, eye-level risers are available to customize the microscope.



Low position



High position



E2-TB binocular tube

E2-TF trinocular tube

* Eyepiece lens is optional.

Eyepieces

The E200's new eyepieces feature a wider field of view for a microscope of this class and are available in 10X (F.O.V. 20) and 15X (F.O.V. 12) types. These eyepieces also feature built-in diopter adjustment that allows the operator to adjust diopters separately for the right and left easily. In addition, these eyepieces accept measuring reticles that will always be in sharp focus with the specimen. Moreover, they can be locked, preventing theft and eliminating the possibility of damage during transit.



F.O.V. 20 (E200)



F.O.V. 18 (conventional model)

New

Refocusing stage

Nikon has created a unique innovation. The Refocusing Stage eliminates the need to refocus the image manually, making specimen handling safer and easier. In this unique design, the stage can be instantly dropped by pushing it down to exchange specimens or oil the slide, then returns to the original position as soon as the hand is removed. The wide stage surface can accommodate two slide glasses at the same time.

- In addition, this stage has an array of features including:
- Increased resistance to vibrations due to the design of the in-base focus mechanism.
 - Low-profile design that creates more space around the objective for increased freedom in specimen handling and easier operation.
 - A belt-drive mechanism to eliminate the projection of the rack at the edge of the stage for better ergonomics and smoother movement.
 - Removable specimen holder for fast hand scanning of slides.
 - Improved XY cross travel, providing the comfort and feel similar to Nikon's higher grade Eclipse series microscopes.



Wide stage surface with no rack sticking out of the stage



New

Upper limit stopper

When using short-working-distance objectives such as 40X or greater, you can set the upper limit of the stage movement, so that the objective doesn't hit the specimen slide, protecting both from damage. Thanks to this feature, even novices or operators who need to change slides often can perform their job easily and quickly. The limit height can be set in two levels using a stopper bolt—either at the standard position or 2mm lower. This feature is very useful except when extraordinarily thick specimens are used.

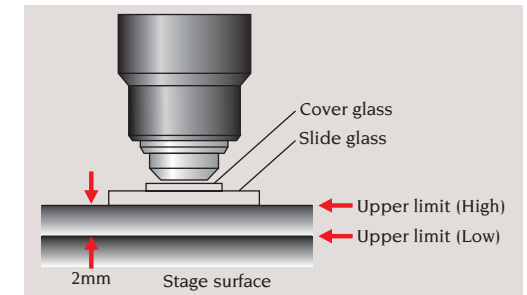

Revolving nosepiece

A reversed-type nosepiece creates more space at the front of the stage, making handling of specimen slides fast and easy. In addition, the CFI60 optical design eliminates extra optical elements in the nosepiece for enhanced image sharpness. Another advantage of CFI60 objectives is that their increased objective lengths and longer working distances provide more working space around the nosepiece.



A wealth of accessories to broaden the range of microscopic applications



Condenser

Although the stage is low-positioned for comfort, there is ample space around the condenser for easy access. The condenser also features an aperture diaphragm that comes complete with position guide markings for respective E Plan objectives to make operation quick and easy.



Improved

Replacing the lamp is safe and easy

Turning the microscope upside down to replace the lamp is no longer necessary. Simply open the lens unit cover to make replacement.

Model with field diaphragm available.

A model with a built-in field diaphragm allows the use of Koehler illumination. It features:

- A field lens unit with a field diaphragm that has position-guide markings for respective objectives.
- Easy and safe lamp replacement procedure.



Field diaphragm with position-guide markings



E200-F

Wide variety of condensers

Abbe, Phase, and other Eclipse series condensers, except the universal type, can be used with the E200.



E2 Abbe condenser (left) and E2 phase condenser

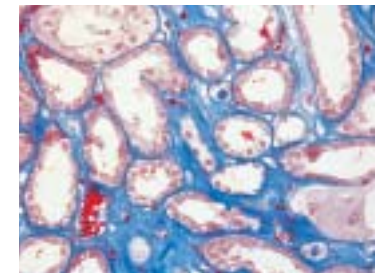

Phase contrast

Simple phase contrast observation at 10X, 20X and 40X is possible with a single phase annulus slider.

The aperture diaphragm automatically opens when the slider is inserted into the condenser. Phase contrast 100X slider and darkfield slider up to 40X objectives are available as options.

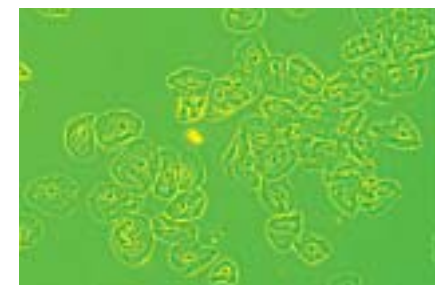

CFI Achromat DL objectives for phase contrast



Epi-fluorescence

The E200-dedicated epi-fluorescence attachment is available for users who want to begin fluorescence observation. Although affordably priced, this attachment allows comprehensive epi-fluorescence as well as UV excitation observations.



Filters are optional.

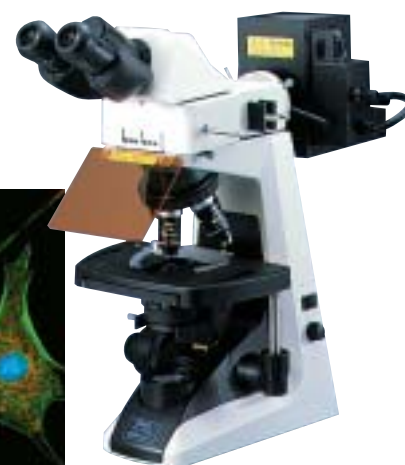
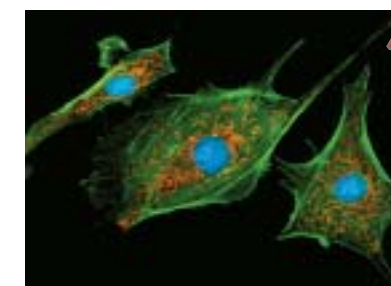

Simple polarizing

This method is ideal for observing amyloid and crystals. To set up, install the polarizer over the field lens and the analyzer.



Simple polarizing set C

Accessories (cont'd.)

System Diagram

Ergonomic binocular tube

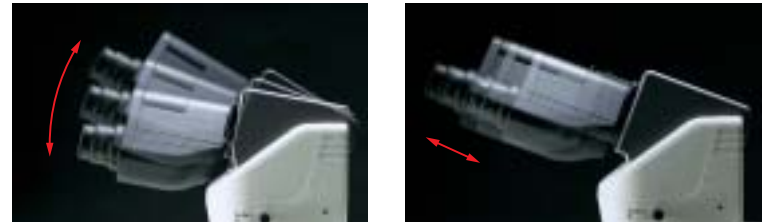

Both eyepiece length and tilt angle are adjustable.

Eye-level riser

Two risers can be inserted to increase the eyepoint height—25mm per riser for a total of 50mm.



Teaching heads

Face-to-face* and side-by-side teaching heads are available.

* Not recommended for use in conjunction with a photomicrographic system, because it makes the microscope top-heavy.



Object marker

Allows the point of interest within a specimen to be marked with ink.

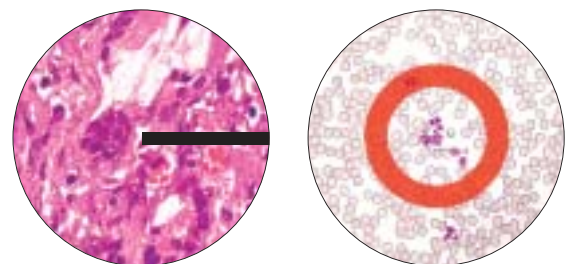

Drawing tube

Allows accurate sketching of the image being observed.



Digital Sight series digital camera system

When the trinocular eyepiece tube is used, a digital camera can be attached.* The DS-Fi1-L2, a color camera head combined with a standalone control unit, enables focusing and viewing of images on the built-in 8.4-in. LCD monitor without the need for a PC.

The optimum imaging conditions that match the observation technique in use can be automatically set by clicking on the appropriate "scene mode." Storing optimal images is easy.

*With a 4x objective lens, the image may show uneven illumination depending on the camera used.

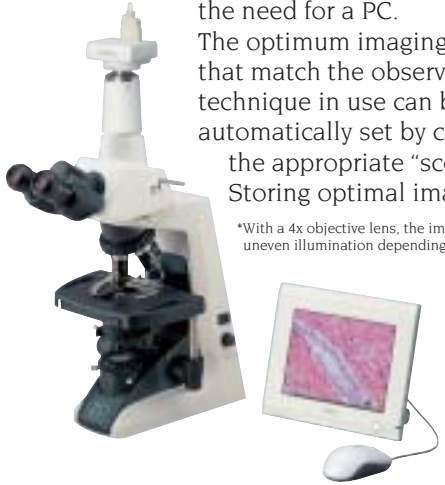

Plastic storage case

The rugged, lightweight storage case is handy for transporting and storing the E200.



ND filter for objective lenses (ND3)

When this filter is used in combination with a 4x or 10x objective lens, image brightness can be adjusted to nearly equal to that of a 40x objective lens.

